

Block and Bleed Valves

BB, DB, SB and DBB Series



Contents

BB Series: Single Block and Bleed Valves	C-28
--	------

DB Series: Double Block Valves	C-34
--------------------------------	------

SB Series: Single Block Valves	C-35
--------------------------------	------

DBB Series: Double Block and Bleed Valves	C-36
---	------

Features

- ⦿ Pressure ratings in accordance with ASME B16.34
- ⦿ Color coded handles indicate functions
- ⦿ Every valve is factory tested in accordance with API 598 or EN 12266
- ⦿ Flange connections comply with ASME B16.5, EN 1092-1 compliance is also available upon request
- ⦿ Bleed port equipped with plug
- ⦿ Weight, space and cost saving over traditional design

Ball Valve Model

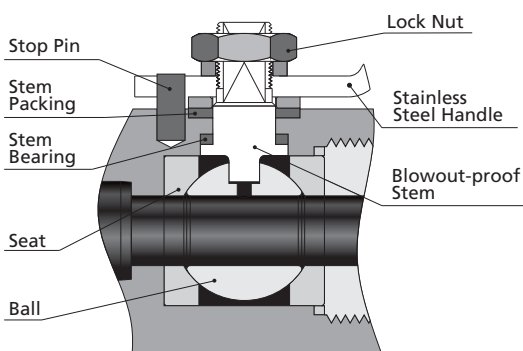

Features

- ⦿ Pressure rating up to: Class 2500
- ⦿ Working temperature : -65°F to 450°F (-54°C to 232°C)
- ⦿ Actuate at quarter-turn
- ⦿ Directional stem flats show open or closed position
- ⦿ Bottom-loaded stem prevents stem blowout and enhances system safety
- ⦿ High-strength stem bearing provides smooth actuation and eliminates galling between valve stem and body
- ⦿ It may be required to adjust the packing during the service life of the valve
- ⦿ FITOK ball valves are designed to be operated in a fully open or fully closed position

Needle Type Valve Model

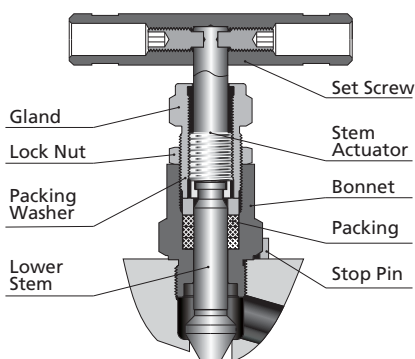

Features

- ⦿ Pressure rating up to: Class 4500
- ⦿ Working temperatures are as follows:
PTFE: -65°F to 450°F (-54°C to 232°C)
Graphite: -65°F to 1200°F (-54°C to 649°C)
- ⦿ Two-piece stem design: Upper stem threads cold rolled and hardened lower stem for high strength and smooth operation
- ⦿ Upper stem thread lubricant is isolated from system fluid
- ⦿ Linear instead of rotary motion of the rising, non-rotating stem minimizes packing abrasion and reduces the friction between the seat and the tip
- ⦿ Stem back seating seals in fully open position
- ⦿ Double lock-pins enable steady and durable fastening of the handle

OS&Y Needle Type Valve Model

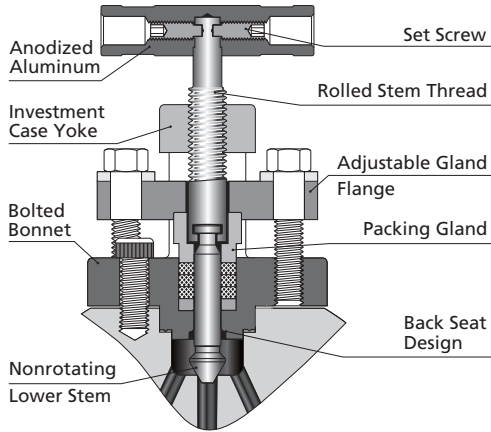

Features

- ⦿ Pressure rating up to: Class 2500
- ⦿ Working temperatures are as follows:
 - PTFE: -65°F to 450°F (-54°C to 232°C)
 - Graphite: -65°F to 1200°F (-54°C to 649°C)
- ⦿ Two-piece stem design: Upper stem threads cold rolled and hardened lower stem for high strength and smooth operation
- ⦿ Upper stem thread lubricant is isolated from system fluid
- ⦿ Linear instead of rotary motion of the rising, non-rotating stem minimizes packing abrasion and reduces the friction between the seat and the tip
- ⦿ Bolted bonnet enhances strength and reliability
- ⦿ Back seat design provides secondary stem sealing and prevents stem blowout
- ⦿ Adjustable gland flange allows easy access to the packing gland and packing adjustment for an effective stem seal
- ⦿ Investment case yoke is formed by precision casting which enhances strength and perfect stem alignment
- ⦿ Two handle pins make the handle fixed firmly and lastingly

Handle colors indicate functions:

Needle and OS&Y valves:

BLACK = Isolate/Block **RED** = Vent/Bleed

Ball valves:

YELLOW = Isolate/Block **RED** = Vent/Bleed

Standard Materials of Construction

Component	Body Material				
	Stainless Steel		Carbon Steel	Duplex Stainless Steel	
	Material Grade/Specification				
Body/End Connector	316 SS, 316L SS /A182	316 SS, 316L SS /A479	A105, LF2/A350	F51/A182	S31803/A479
Ball Valve	Ball	316 SS, 316L SS/A479			S31803/A479
	Stem				
	Washer				
	Stop Block	304 SS/A240			
	Seat	PEEK/PCTFE			
	Needle Type Globe Valve	Stem Tip	316 SS, 316L SS/A479		
Stem					
Bonnet					
OS&Y Needle Type Globe Valve	Stem Tip	316 SS, 316L SS/A479			S31803/A479
	Stem				
	Packing Gland				
	Yoke				

Stainless steel is standard material, others are available upon request.

Flange Connection

Pressure - Temperature Rating

FITOK Block and Bleed Valves offer a variety of sizes and pressure ratings of the flange in accordance with ASME B16.5 Specifications. Ratings are taken from ASME B16.5, Table 2-2.2 and Table F2-2.2. The rating data are based on stainless steel F316/A182.

Temp. °C	ASME Ratings					
	150	300	600	900	1500	2500
	Working Pressure, bar					
-29 to 38	19.0	49.6	99.3	148.9	248.2	413.7
50	18.4	48.1	96.2	144.3	240.6	400.9
100	16.2	42.2	84.4	126.6	211.0	351.6
150	14.8	38.5	77.0	115.5	192.5	320.8
200	13.7	35.7	71.3	107.0	178.3	297.2
250	12.1	33.4	66.8	100.1	166.9	278.1
300	10.2	31.6	63.2	94.9	158.1	263.5
325	9.3	30.9	61.8	92.7	154.4	257.4
350	8.4	30.3	60.7	91.0	151.6	252.7
375	7.4	29.9	59.8	89.6	149.4	249.0
400	6.5	29.4	58.9	88.3	147.2	245.3
425	5.5	29.1	58.3	87.4	145.7	242.9
450	4.6	28.8	57.7	86.5	144.2	240.4

Temp. °F	ASME Ratings					
	150	300	600	900	1500	2500
	Working Pressure, psig					
-20 to 100	275	720	1440	2160	3600	6000
200	235	620	1240	1860	3095	5160
300	215	560	1120	1680	2795	4660
400	195	515	1025	1540	2570	4280
500	170	480	955	1435	2390	3980
600	140	450	900	1355	2255	3760
650	125	440	885	1325	2210	3680
700	110	435	870	1305	2170	3620
750	95	425	855	1280	2135	3560
800	80	420	845	1265	2110	3520
850	65	420	835	1255	2090	3480

Sour Gas Service/NACE Compliant

Process interface valves for sour gas service are available. Materials are selected in accordance with NACE MR0175/ISO 15156. Contact FITOK Group or our authorized distributors if you have any request.

BB Series: Single Block and Bleed Valves

Instrument Single Block and Bleed Valves

Features

- ⊙ Threaded or one-piece forged body
- ⊙ Orifice (all-ball-valve configuration, ball-and-needle-valve configuration) : Ball 3/8 in. (9.5 mm), Needle 0.16 in. (4 mm); Orifice (all-needle-valve configuration) : 0.16 in. (4 mm) is standard, 0.25 in. (6.4 mm) and 0.38 in. (9.5 mm) are available upon request.

Block: ball Bleed: ball (configuration: BB)

Basic Ordering Number	Inlet/Process	Outlet/Instrument	Vent/Bleed
BB□□-BB-FNS8-V4-C	1/2 female NPT	1/2 female NPT	1/4 female NPT
BB□□-BB-FNS8-V4-CG	1/2 female NPT	1/2 female NPT	1/4 female NPT

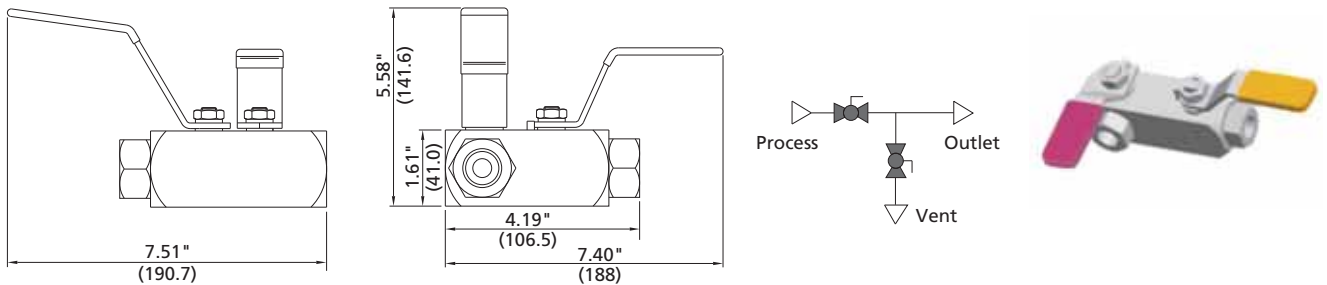

Block: ball Bleed: needle (configuration: BN)

Basic Ordering Number	Inlet/Process	Outlet/Instrument	Vent/Bleed
BB□□-BN-FNS8-V4-V	1/2 female NPT	1/2 female NPT	1/4 female NPT
BB□□-BN-FNS8-V4-VG	1/2 female NPT	1/2 female NPT	1/4 female NPT
BB□□-BN-FNS8-NS8-V4-V	1/2 female NPT	1/2 male NPT	1/4 female NPT
BB□□-BN-FNS8-NS8-V4-VG	1/2 female NPT	1/2 male NPT	1/4 female NPT

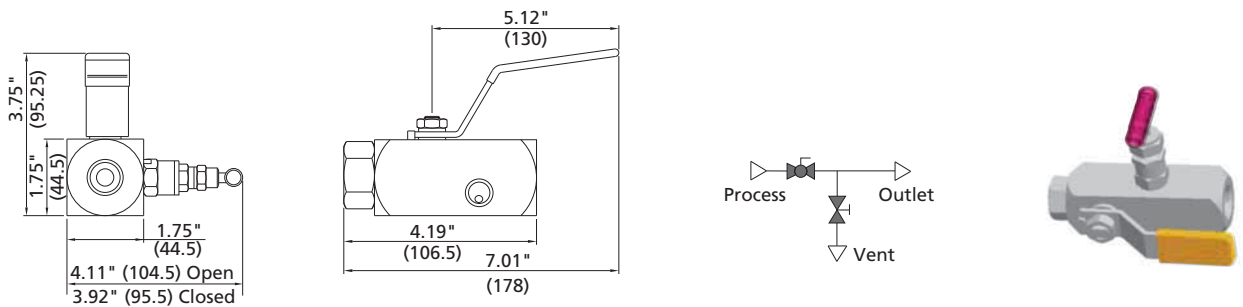

Manifolds

Block: needle Bleed: needle (configuration: NN)

Basic Ordering Number	Inlet/Process	Outlet/Instrument	Vent/Bleed
BB□□-NN-NS8-FNS8-V4-H	1/2 male NPT	1/2 female NPT	1/4 female NPT
BB□□-NN-NS12-FNS8-V4-HG	3/4 male NPT	1/2 female NPT	1/4 female NPT

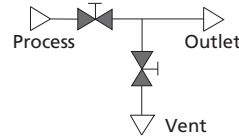
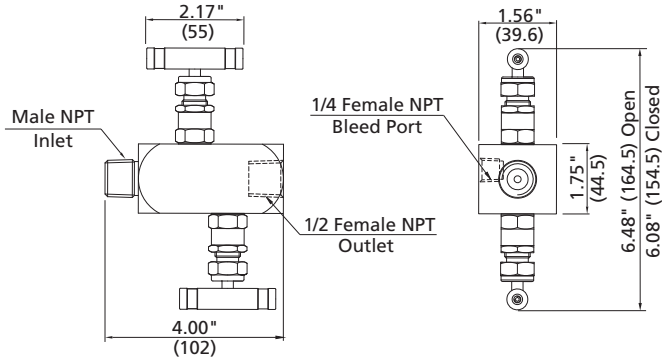

Flange Single Block and Bleed Valves

Features

- ⊙ Threaded or one-piece forged body
- ⊙ Piping and instrument valves in one body
- ⊙ 1/2 female NPT standard outlet
- ⊙ Orifice (ball-and-needle-valve configuration) : Ball 3/8 in. (9.5 mm), Needle 0.16 in. (4 mm);
Orifice (all-ball-valve configuration) : 3/8 in. (9.5 mm)

Block: ball Bleed: needle (configuration: BN)

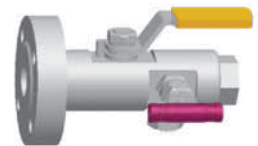
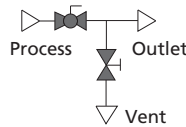
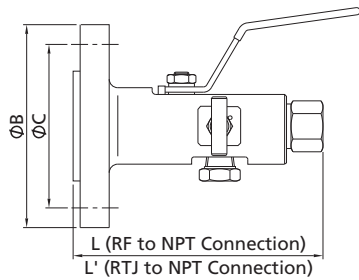

Block: ball Bleed: needle (configuration: BN)

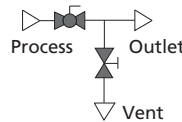
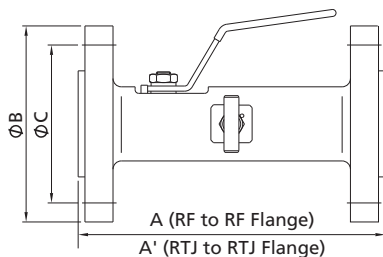

C-30 Block and Bleed Valves

Block: ball Bleed: ball (configuration: BB)

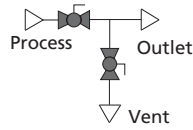
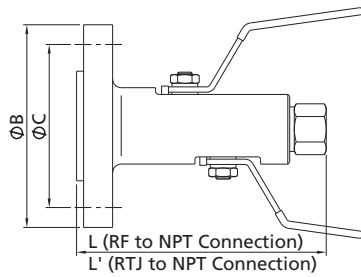

Block: ball Bleed: ball (configuration: BB)

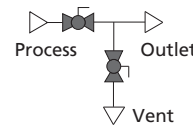
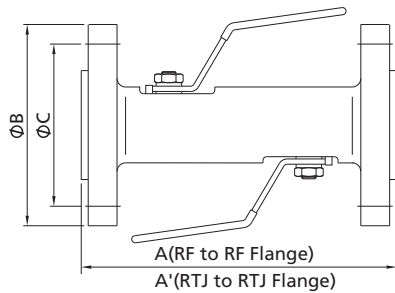

Flange Size	Bore Size in. (mm)	ASME Class	L in. (mm)	L' in. (mm)	A in. (mm)	A' in. (mm)	ϕB in. (mm)	ϕC in. (mm)
NPS 1/2 (DN 15)	3/8 (9.5)	150	4.88 (124.0)	—	6.41 (162.8)	—	3.54 (90)	2.37 (60.3)
		300		4.88 (124.0)	6.81 (173.0)	6.81 (173.0)	3.74 (95)	2.63 (66.7)
		600	5.67 (144.0)	5.67 (144.0)	7.99 (202.9)	7.99 (202.9)	4.72 (120)	3.25 (82.6)
		900/1500		5.67 (144.0)	7.99 (202.9)	7.99 (202.9)	5.31 (135)	3.50 (88.9)
		2500		5.67 (144.0)	7.99 (202.9)	7.99 (202.9)	5.31 (135)	3.50 (88.9)
NPS 3/4 (DN 20)	3/8 (9.5)	150	4.88 (124.0)	—	6.41 (162.8)	—	3.94 (100)	2.75 (69.9)
		300		4.88 (124.0)	6.81 (173.0)	6.81 (173.0)	4.53 (115)	3.25 (82.6)
		600	5.67 (144.0)	5.67 (144.0)	7.99 (202.9)	7.99 (202.9)	5.12 (130)	3.50 (88.9)
		900/1500		5.67 (144.0)	7.99 (202.9)	7.99 (202.9)	5.51 (140)	3.75 (95.2)
		2500		5.67 (144.0)	7.99 (202.9)	7.99 (202.9)	5.51 (140)	3.75 (95.2)
NPS 1 (DN 25)	3/8 (9.5)	150	4.88 (124.0)	4.88 (124.0)	6.41 (162.8)	6.61 (167.9)	4.33 (110)	3.13 (79.4)
		300			7.00 (177.8)	7.00 (177.8)	4.92 (125)	3.50 (88.9)
		600	5.98 (151.9)	5.98 (151.9)	10.30 (261.6)	10.30 (261.6)	5.91 (150)	4.00 (101.6)
		900/1500			10.70 (271.8)	10.70 (271.8)	6.30 (160)	4.25 (108.0)
		2500			12.40 (315.0)	12.40 (315.0)	8.07 (205)	5.75 (146)
NPS 1 1/2 (DN 40)	3/8 (9.5)	150	5.98 (151.9)	5.98 (151.9)	8.90 (226.1)	9.49 (241.0)	4.92 (125)	3.87 (98.4)
		300			9.89 (251.2)	9.89 (251.2)	6.10 (155)	4.50 (114.3)
		600	6.61 (167.9)	6.61 (167.9)	11.50 (292.1)	11.50 (292.1)	7.09 (180)	4.87 (123.8)
		900/1500			12.40 (315.0)	12.40 (315.0)	8.07 (205)	5.75 (146)
		2500			12.40 (315.0)	12.40 (315.0)	8.07 (205)	5.75 (146)
NPS 2 (DN 50)	3/8 (9.5)	150	5.98 (151.9)	5.98 (151.9)	9.09 (230.9)	9.49 (241.0)	5.91 (150)	4.75 (120.7)
		300			10.10 (256.5)	10.30 (261.6)	6.50 (165)	5.00 (127.0)
		600	6.61 (167.9)	6.61 (167.9)	12.00 (304.8)	12.00 (304.8)	8.46 (215)	6.50 (165.1)
		900/1500			13.60 (345.4)	13.60 (345.4)	9.25 (235)	6.75 (171.4)
		2500			13.60 (345.4)	13.60 (345.4)	9.25 (235)	6.75 (171.4)

Dimensions are for reference only and are subject to change.

Root Single Block and Bleed Valves

Features

- Directly-mounted root valves available to the vessel or process pipe
- Weld inlet connection sizes from NPS 1/2 to NPS 2
- 1/2 female NPT standard vent with plug
- 1/2 female NPT standard outlet
- Orifice (ball-and-needle-valve configuration) : Ball 3/8 in. (9.5 mm), Needle 0.16 in. (4 mm);
Orifice (all-needle-valve configuration) : 0.16 in. (4 mm) is standard, 0.25 in. (6.4 mm) and 0.38 in. (9.5 mm) are available upon request.

Block: ball Bleed: needle (configuration: BN)

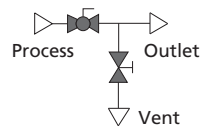
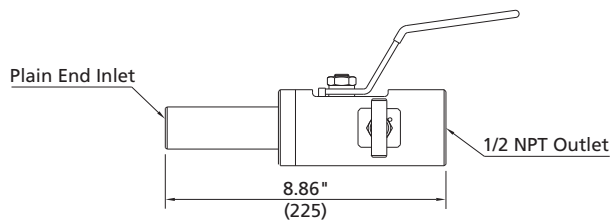

Block: ball Bleed: OS&Y (configuration: BO)

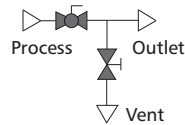
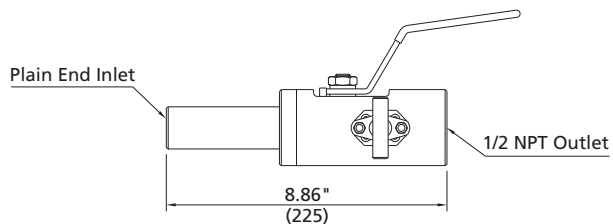

Block: OS&Y Bleed: needle (configuration: ON)

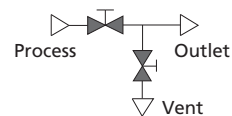
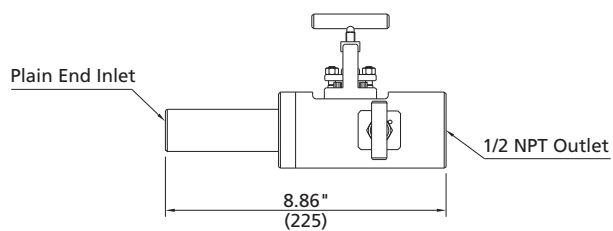

Block: needle Bleed: needle (configuration: NN)

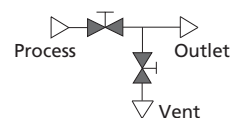
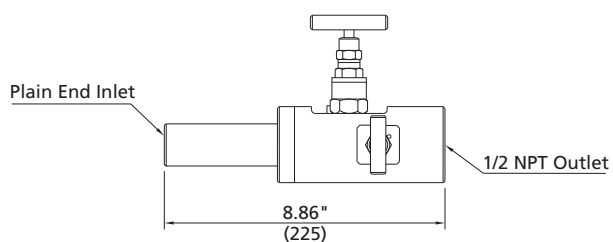

Dimensions are for reference only and are subject to change.

Monoflange Single Block and Bleed Valves

Features

- Piping and instrument valves in one body
- 1/4 female NPT standard vent with plug
- 1/2 female NPT standard outlet
- Orifice: 0.16 in. (4 mm) is standard, 0.25 in. (6.4 mm) and 0.38 in. (9.5 mm) are available for some flange sizes

Block: OS&Y Bleed: needle (configuration: ON)

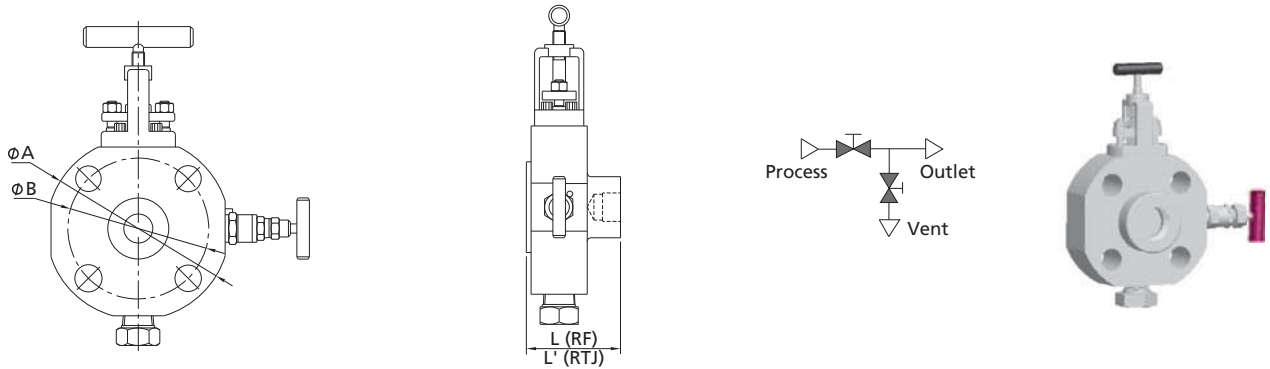

Block: needle Bleed: needle (configuration: NN)

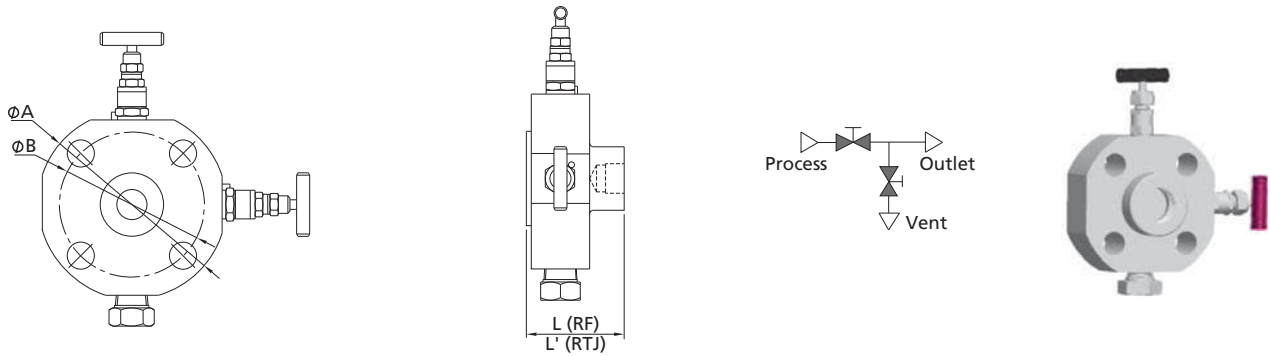

Block: OS&Y Bleed: needle (configuration: ON, Two Vents)

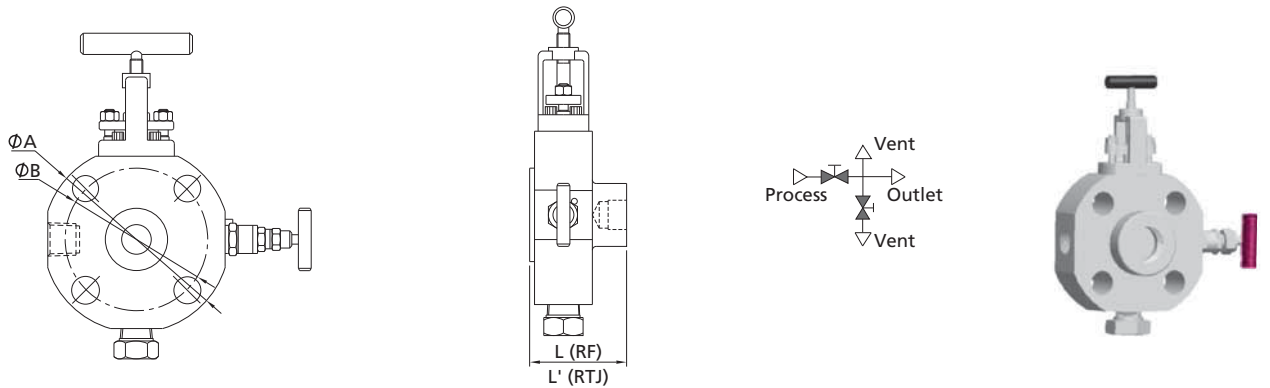

Block: needle Bleed: needle (configuration: NN, Two Vents)

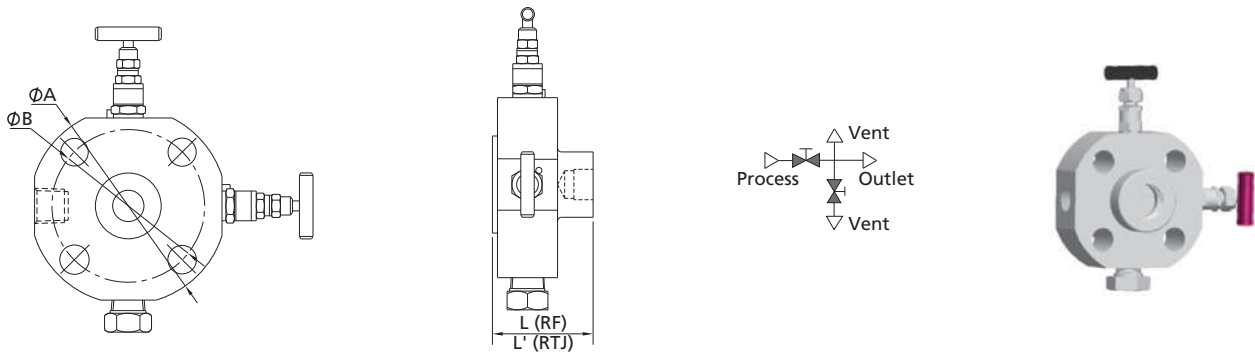

Flange Size	Bore Size in. (mm)	ASME Class	L in. (mm)	L' in. (mm)	Ø A in. (mm)	Ø B in. (mm)
NPS 1/2 (DN 15)	0.16 (4.0)	150	2.03 (51.6)	—	3.54 (90)	2.37 (60.3)
		300		2.03 (51.6)	3.74 (95)	2.63 (66.7)
		600			4.72 (120)	3.25 (82.6)
		900/1500			5.31 (135)	3.50 (88.9)
		2500			3.94 (100)	2.75 (69.9)
NPS 3/4 (DN 20)		150	2.03 (51.6)	2.03 (51.6)	4.53 (115)	3.25 (82.6)
		300			5.12 (130)	3.50 (88.9)
		600			5.51 (140)	3.75 (95.2)
		900/1500			2.11 (53.5)	2.11 (53.5)
		NPS 1 (DN 25)	150	2.03 (51.6)	2.03 (51.6)	4.33 (110)
300	4.92 (125)		3.50 (88.9)			
600	5.91 (150)		4.00 (101.6)			
NPS 1 1/2 (DN 40)	900/1500		2.11 (53.5)	2.11 (53.5)	6.30 (160)	4.25 (108.0)
	2500		150	2.03 (51.6)	2.03 (51.6)	4.92 (125)
	300	2.11 (53.5)	2.11 (53.5)	6.10 (155)	4.50 (114.3)	
	600			7.09 (180)	4.87 (123.8)	
	NPS 2 (DN 50)	900/1500	2.19 (55.5)	2.19 (55.5)	8.07 (205)	5.75 (146)
2500		150	2.11 (53.5)	2.11 (53.5)	5.91 (150)	4.75 (120.7)
300		2.19 (55.5)	2.19 (55.5)	6.50 (165)	5.00 (127.0)	
600				8.49 (215)	6.50 (165.1)	
900/1500		2.42 (61.5)	2.42 (61.5)	9.25 (235)	6.75 (171.4)	
2500	2.88 (73.4)	2.88 (73.4)	9.25 (235)	6.75 (171.4)		

Dimensions are for reference only and are subject to change.

DB Series: Double Block Valves

Monoflange Double Block Valves

Features

- Piping and instrument valves in one body
- 1/2 female NPT standard outlet
- Orifice: 0.16 in. (4 mm) is standard, 0.25 in. (6.4 mm) and 0.38 in. (9.5 mm) are available for some flange sizes

Primary: OS&Y Secondary: needle (configuration: ON)

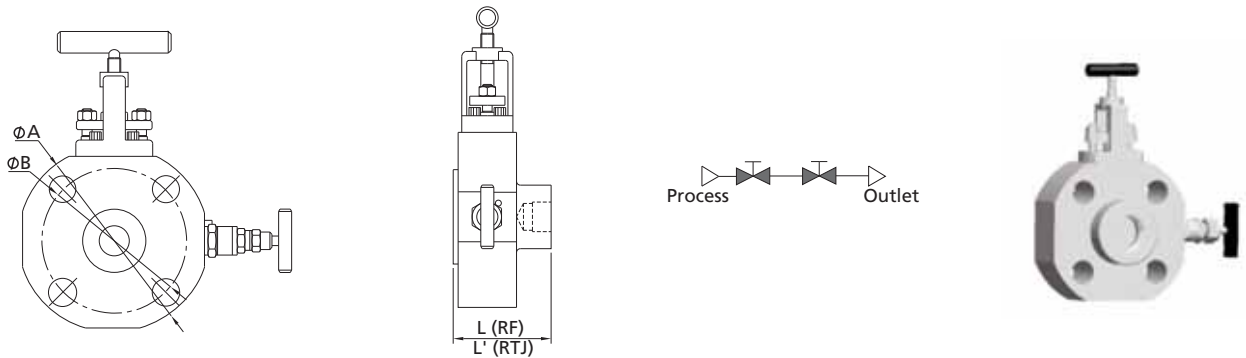

Primary: needle Secondary: needle (configuration: NN)

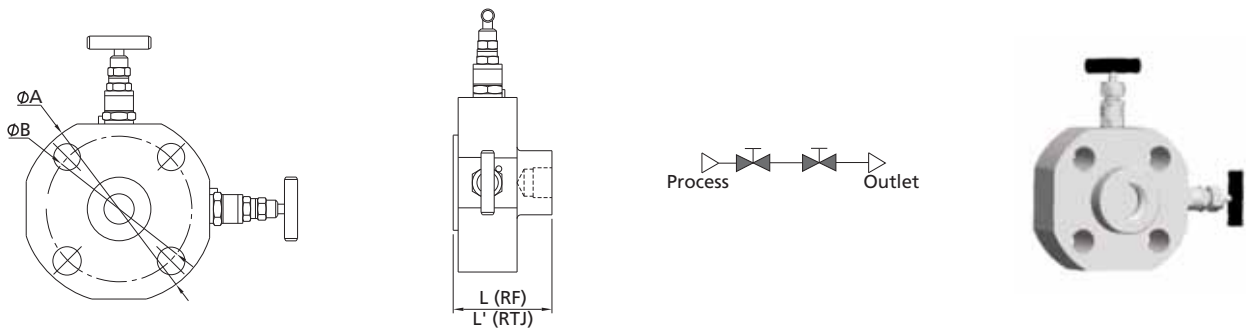

Dimensions are the same as the monoflange single block & bleed valves

SB Series: Single Block Valves

Monoflange Single Block Valves

Features

- Piping and instrument valves in one body
- 1/2 female NPT standard outlet
- Orifice: 0.16 in. (4 mm) is standard, 0.25 in. (6.4 mm) and 0.38 in. (9.5 mm) are available for some flange sizes

Block: OS&Y (O)

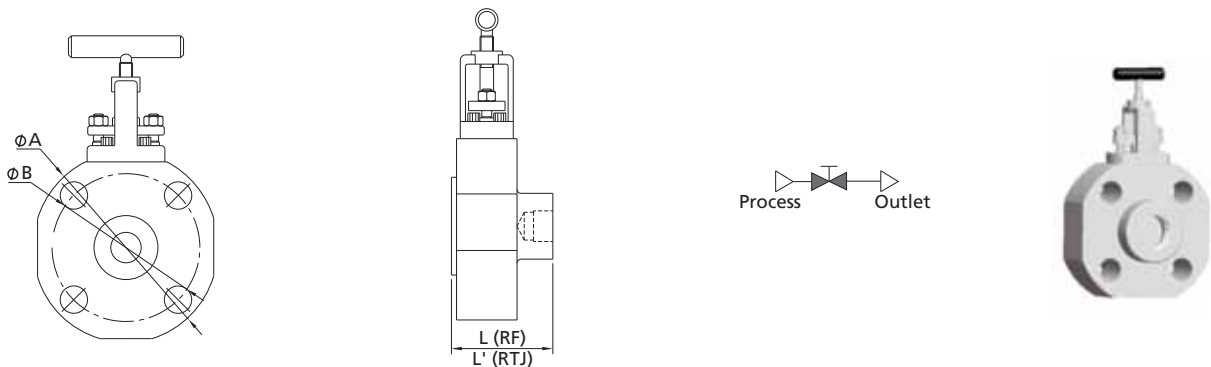

Block: needle (N)

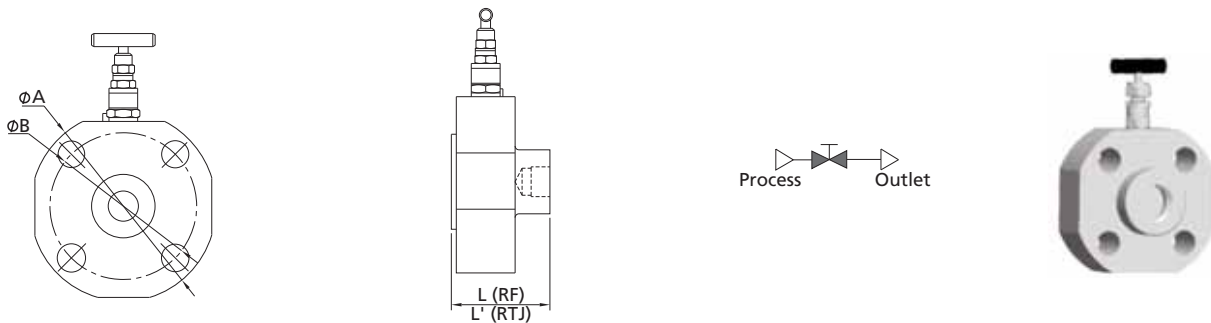

Dimensions are the same as the Monoflange single block & bleed valves

DBB Series: Double Block and Bleed Valves

Instrument Double Block and Bleed Valves

Features

- ⊙ Threaded or one-piece forged body
- ⊙ Optional port sizes and thread forms available
- ⊙ Orifice (all-ball-valve configuration, ball-and-needle-valve configuration) : Ball 3/8 in. (9.5 mm), Needle 0.16 in. (4 mm); Orifice (all-needle-valve configuration) : 0.16 in. (4 mm) is standard, 0.25 in. (6.4 mm) and 0.38 in. (9.5 mm) are available upon request

Primary: ball Secondary: needle Bleed: needle (configuration: BNN)

Basic Ordering Number	Inlet/Process	Outlet/Instrument	Vent/Bleed
DBB□□-BNN-FNS8-V4-V	1/2 female NPT	1/2 female NPT	1/4 female NPT
DBB□□-BNN-FNS8-V4-VG	1/2 female NPT	1/2 female NPT	1/4 female NPT

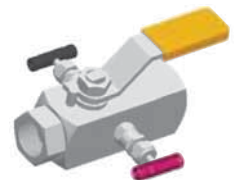
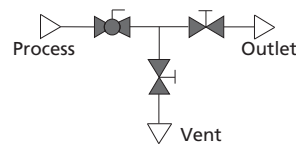
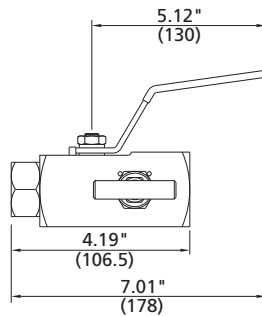
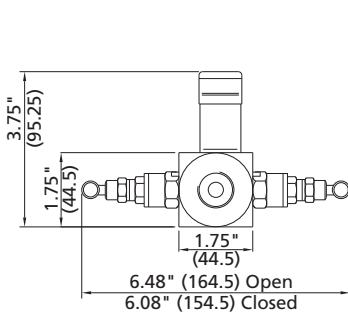

Primary: ball Secondary: ball Bleed: needle (configuration: BBN)

Basic Ordering Number	Inlet/Process	Outlet/Instrument	Vent/Bleed
DBB□□-BBN-FNS8-V4-V	1/2 female NPT	1/2 female NPT	1/4 female NPT
DBB□□-BBN-FNS8-V4-VG	1/2 female NPT	1/2 female NPT	1/4 female NPT

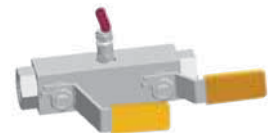
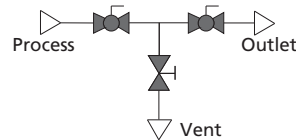
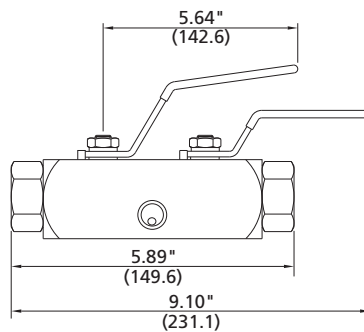
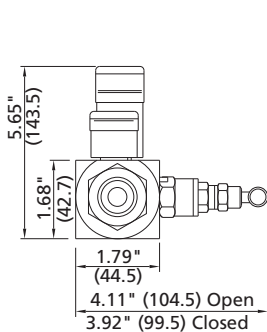

Manifolds

Primary: ball Secondary: ball Bleed: ball (configuration: BBB)

Basic Ordering Number	Inlet/Process	Outlet/Instrument	Vent/Bleed
DBB□□-BBB-FNS8-V4-C	1/2 female NPT	1/2 female NPT	1/4 female NPT
DBB□□-BBB-FNS8-V4-CG	1/2 female NPT	1/2 female NPT	1/4 female NPT

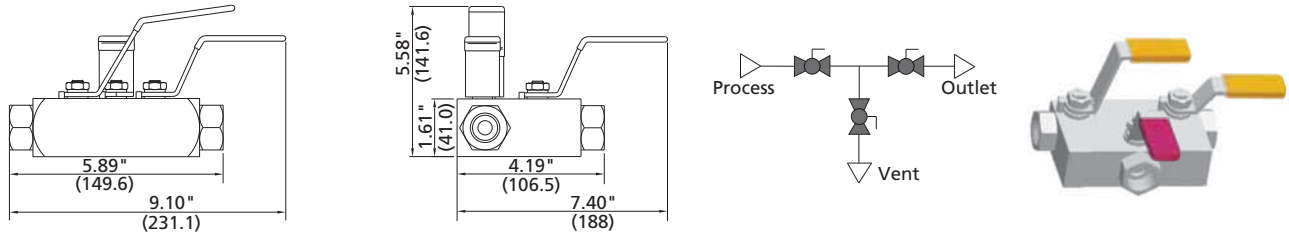

Primary: ball Secondary: ball Bleed: ball (configuration: BBB)

Basic Ordering Number	Inlet/Process	Outlet/Instrument	Vent/Bleed
DBB□□-BBB-FNS8-V4-L	1/2 female NPT	1/2 female NPT	1/4 female NPT
DBB□□-BBB-FNS8-V4-LG	1/2 female NPT	1/2 female NPT	1/4 female NPT

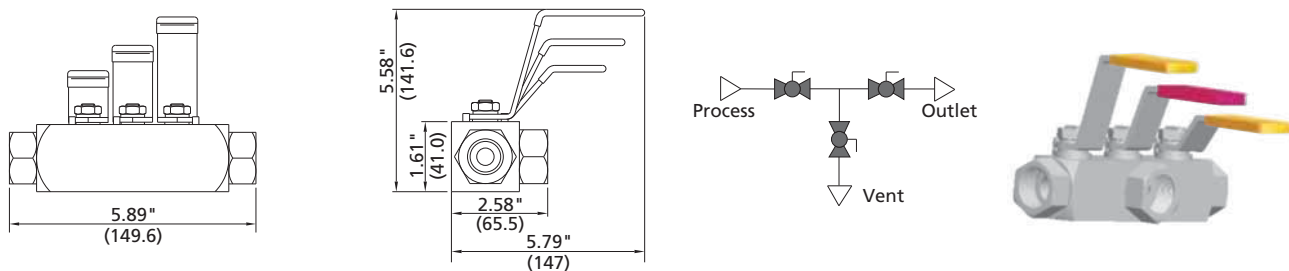

Primary: needle Secondary: needle Bleed: needle (configuration: NNN)

Basic Ordering Number	Inlet/Process	Outlet/Instrument	Vent/Bleed
DBB□□-NNN-NS8-FNS8-V4-V	1/2 male NPT	1/2 female NPT	1/4 female NPT
DBB□□-NNN-NS12-FNS8-V4-VG	3/4 male NPT	1/2 female NPT	1/4 female NPT

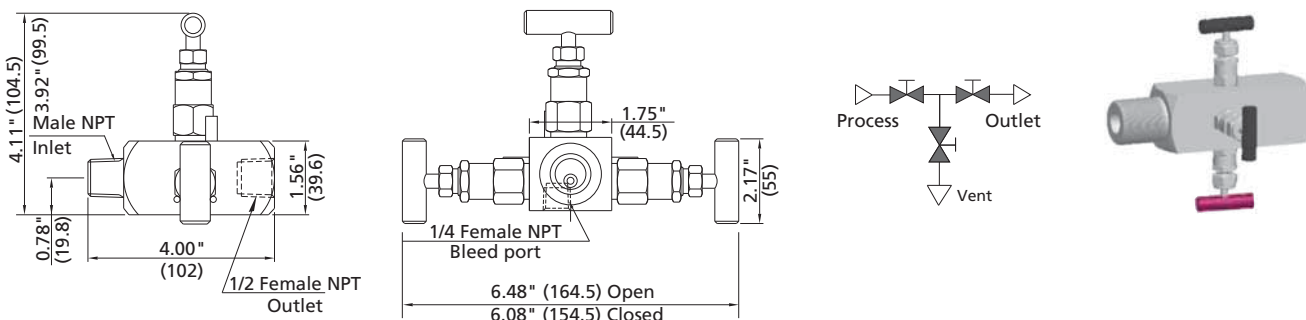

Manifolds

Flange Double Block and Bleed Valves

Features

- ⦿ One piece forged body minimizes potential leak paths
- ⦿ Piping and instrument valves in one body
- ⦿ 1/2 female NPT standard outlet
- ⦿ Orifice (ball-and-needle-valve configuration) : Ball 3/8 in. (9.5 mm), Needle 0.16 in. (4 mm);
Orifice (all-needle-valve configuration) : 0.38 in. (9.5 mm)

Primary: ball Secondary: ball Bleed: needle (configuration: BBN)

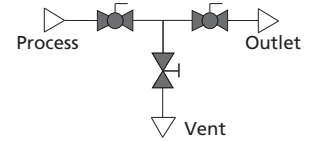
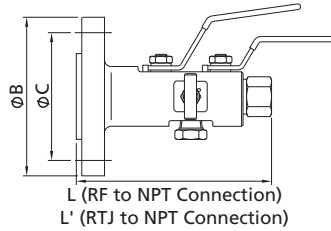
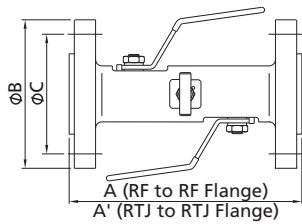

Flange Size	Bore Size in. (mm)	ASME Class	L in. (mm)	L' in. (mm)	A in. (mm)	A' in. (mm)	ØB in. (mm)	ØC in. (mm)		
NPS 1/2 (DN 15)	3/8 (9.5)	150	5.91 (150.1)	—	6.41 (162.8)	—	3.54 (90)	2.37 (60.3)		
		300		5.91 (150.1)	6.81 (173.0)	6.81 (173.0)	3.74 (95)	2.63 (66.7)		
		600	6.69 (170.0)	6.69 (170.0)	7.99 (202.9)	7.99 (202.9)	4.72 (120)	3.25 (82.6)		
		900/1500		6.69 (170.0)	7.99 (202.9)	7.99 (202.9)	5.31 (135)	3.50 (88.9)		
		2500		6.69 (170.0)	7.99 (202.9)	7.99 (202.9)	5.31 (135)	3.50 (88.9)		
NPS 3/4 (DN 20)	3/8 (9.5)	150	5.91 (150.1)	—	6.41 (162.8)	—	3.94 (100)	2.75 (69.9)		
		300		5.91 (150.1)	6.81 (173.0)	6.81 (173.0)	4.53 (115)	3.25 (82.6)		
		600	6.69 (170.0)	6.69 (170.0)	7.99 (202.9)	7.99 (202.9)	5.12 (130)	3.50 (88.9)		
		900/1500		6.69 (170.0)	7.99 (202.9)	7.99 (202.9)	5.51 (140)	3.75 (95.2)		
		2500		6.69 (170.0)	7.99 (202.9)	7.99 (202.9)	5.51 (140)	3.75 (95.2)		
NPS 1 (DN 25)	3/8 (9.5)	150	5.91 (150.1)	5.91 (150.1)	6.41 (162.8)	6.61 (167.9)	4.33 (110)	3.13 (79.4)		
		300			7.00 (177.8)	7.00 (177.8)	4.92 (125)	3.50 (88.9)		
		600	7.00 (177.8)	7.00 (177.8)	10.30 (261.6)	10.30 (261.6)	5.91 (150)	4.00 (101.6)		
		900/1500			7.00 (177.8)	7.00 (177.8)	10.70 (271.8)	10.70 (271.8)	6.30 (160)	4.25 (108.0)
		2500			7.00 (177.8)	7.00 (177.8)	10.70 (271.8)	10.70 (271.8)	6.30 (160)	4.25 (108.0)
NPS 1 1/2 (DN 40)	3/8 (9.5)	150	7.00 (177.8)	7.00 (177.8)	8.90 (226.1)	9.49 (241.0)	4.92 (125)	3.87 (98.4)		
		300			9.89 (251.2)	9.89 (251.2)	6.10 (155)	4.50 (114.3)		
		600	7.64 (194.1)	7.64 (194.1)	11.50 (292.1)	11.50 (292.1)	7.09 (180)	4.87 (123.8)		
		900/1500			7.64 (194.1)	7.64 (194.1)	12.40 (315.0)	12.40 (315.0)	8.07 (205)	5.75 (146)
		2500			7.64 (194.1)	7.64 (194.1)	12.40 (315.0)	12.40 (315.0)	8.07 (205)	5.75 (146)
NPS 2 (DN 50)	3/8 (9.5)	150	7.00 (177.8)	7.00 (177.8)	9.09 (230.9)	9.49 (241.0)	5.91 (150)	4.75 (120.7)		
		300			10.10 (256.5)	10.30 (261.6)	6.50 (165)	5.00 (127.0)		
		600	7.64 (194.1)	7.64 (194.1)	12.00 (304.8)	12.00 (304.8)	8.46 (215)	6.50 (165.1)		
		900/1500			7.64 (194.1)	7.64 (194.1)	13.60 (345.4)	13.60 (345.4)	9.25 (235)	6.75 (171.4)
		2500			7.64 (194.1)	7.64 (194.1)	13.60 (345.4)	13.60 (345.4)	9.25 (235)	6.75 (171.4)

Manifolds

Primary: OS&Y Secondary: OS&Y Bleed: needle (configuration: OON)

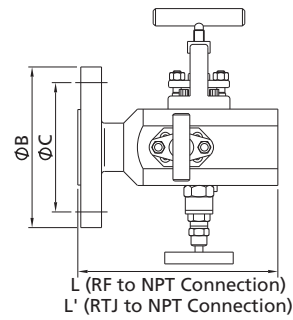
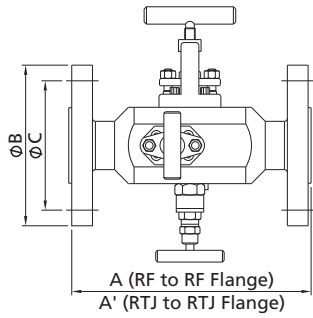

Flange Size	Bore Size in. (mm)	ASME Class	L in. (mm)	L' in. (mm)	A in. (mm)	A' in. (mm)	ϕB in. (mm)	ϕC in. (mm)
NPS 1/2 (DN 15)	0.38 (9.5)	150	4.88 (124.0)	—	6.41 (162.8)	—	3.54 (90)	2.37 (60.3)
		300		4.88 (124.0)	6.81 (173.0)	6.81 (173.0)	3.74 (95)	2.63 (66.7)
		600	5.60 (142.2)	5.60 (142.2)	7.99 (202.9)	7.99 (202.9)	4.72 (120)	3.25 (82.6)
		900/1500					5.31 (135)	3.50 (88.9)
		2500					5.31 (135)	3.50 (88.9)
NPS 3/4 (DN 20)	0.38 (9.5)	150	4.88 (124.0)	—	6.41 (162.8)	—	3.94 (100)	2.75 (69.9)
		300		4.88 (124.0)	6.81 (173.0)	6.81 (173.0)	4.53 (115)	3.25 (82.6)
		600	5.60 (142.2)	5.60 (142.2)	7.99 (202.9)	7.99 (202.9)	5.12 (130)	3.50 (88.9)
		900/1500					5.51 (140)	3.75 (95.2)
		2500					5.51 (140)	3.75 (95.2)
NPS 1 (DN 25)	0.38 (9.5)	150	4.88 (124.0)	4.88 (124.0)	6.41 (162.8)	6.61 (167.9)	4.33 (110)	3.13 (79.4)
		300			7.00 (177.8)	7.00 (177.8)	4.92 (125)	3.50 (88.9)
		600	5.98 (151.9)	5.98 (151.9)	8.90 (226.1)	9.49 (241.0)	10.30 (261.6)	4.00 (101.6)
		900/1500					10.70 (271.8)	4.25 (108.0)
		2500					10.70 (271.8)	4.25 (108.0)
NPS 1 1/2 (DN 40)	0.38 (9.5)	150	5.98 (151.9)	5.98 (151.9)	8.90 (226.1)	9.49 (241.0)	4.92 (125)	3.87 (98.4)
		300			9.89 (251.2)	9.89 (251.2)	6.10 (155)	4.50 (114.3)
		600	6.61 (167.9)	6.61 (167.9)	11.50 (292.1)	11.50 (292.1)	7.09 (180)	4.87 (123.8)
		900/1500					12.40 (315.0)	5.75 (146)
		2500					12.40 (315.0)	5.75 (146)
NPS 2 (DN 50)	0.38 (9.5)	150	5.98 (151.9)	5.98 (151.9)	9.09 (230.9)	9.49 (241.0)	5.91 (150)	4.75 (120.7)
		300			10.10 (256.5)	10.30 (261.6)	6.50 (165)	5.00 (127.0)
		600	6.61 (167.9)	6.61 (167.9)	12.00 (304.8)	12.00 (304.8)	8.46 (215)	6.50 (165.1)
		900/1500					13.60 (345.4)	6.75 (171.4)
		2500					13.60 (345.4)	6.75 (171.4)

Three-Piece Bolted Flange Double Block and Bleed Valves

Features

- ⦿ Complementing the existing one-piece range, flange to flange bolted construction DBB valves available in bore sizes from 3/8 in. to 2 in. (9.5 mm ~ 50.8 mm)
- ⦿ Designed and manufactured according to ASME SI B16.34 and ASME Boiler and Pressure Vessel Code, Section VIII
- ⦿ Three-piece, bolted joint, forged body design
- ⦿ API 607 Fire safe approved by TÜV SÜD. Anti-static design is also available.
- ⦿ Blowout-proof valve stems and needles
- ⦿ Materials are selected in accordance with NACE MR0175/ISO 15156
- ⦿ 1/2 female NPT standard vent

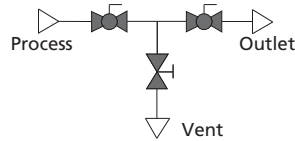
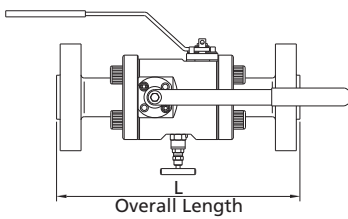

Dimensions

Basic Ordering Number	Flange Size	Bore Size in. (mm)	ASME Class	L in. (mm)
DBB□□-BBN1-□□8□□□-V□-FS-I	NPS 1/2 (DN 15)	1/2 (14)	150	12.6 (321)
			300	12.9 (327)
			600	13.4 (340)
			900/1500	14.4 (366)
			2500	15.0 (382)
DBB□□-BBN2-□□12□□□-V□-FS-I	NPS 3/4 (DN 20)	3/4 (20)	150	12.7 (323)
			300	13.2 (336)
			600	13.7 (349)
			900/1500	14.6 (372)
			2500	15.2 (385)
DBB□□-BBN3-□□16□□□-V□-FS-I	NPS 1 (DN 25)	1 (25.4)	150	13.0 (330)
			300	13.2 (336)
			600	13.8 (350)
			900/1500	15.4 (392)
			2500	16.2 (412)
DBB□□-BBN4-□□24□□□-V□-FS-I	NPS 1 1/2 (DN 40)	1 1/2 (38.1)	150	14.2 (361)
			300	14.4 (367)
			600	15.1 (384)
			900/1500	15.8 (402)
			2500	18.2 (463)
DBB□□-BBN5-□□32□□□-V□-FS-I	NPS 2 (DN 50)	2 (50.8)	150	15.4 (390)
			300	15.7 (398)
			600	16.4 (416)
			900/1500	18.9 (481)

Basic Ordering Number	Flange Size	Bore Size in. (mm)	ASME Class	L in. (mm)
DBB□□-BBN-□□8□□□-V□-FS-I	NPS 1/2 (DN 15)	3/8 (9.5)	150	9.1 (232)
			300	9.9 (252)
			600	10.7 (272)
			900/1500	12.3 (312)
			2500	13.5 (342)
DBB□□-BBN1-□□12□□□-V□-FS-I	NPS 3/4 (DN 20)	1/2 (14)	150	12.8 (324)
			300	13.2 (336)
			600	13.8 (350)
			900/1500	14.6 (372)
			2500	15.2 (385)
DBB□□-BBN2-□□16□□□-V□-FS-I	NPS 1 (DN 25)	3/4 (20)	150	12.9 (327)
			300	13.4 (340)
			600	13.9 (353)
			900/1500	15.1 (384)
			2500	15.6 (397)
DBB□□-BBN3-□□24□□□-V□-FS-I	NPS 1 1/2 (DN 40)	1 (25.4)	150	13.1 (332)
			300	13.9 (352)
			600	15.0 (382)
			900/1500	15.8 (402)
			2500	16.6 (422)
DBB□□-BBN4-□□32□□□-V□-FS-I	NPS 2 (DN 50)	1 1/2 (38.1)	150	12.3 (312)
			300	13.1 (332)
			600	13.9 (352)
			900/1500	15.8 (402)
			2500	16.6 (422)
DBB□□-BBN5-□□48□□□-V□-FS-I	NPS 3 (DN 80)	2 (50.8)	150	14.3 (364)
			300	14.6 (372)
			600	16.9 (428)
			900	17.4 (441)
			1500	19.7 (500)

Dimensions are for reference only and are subject to change.

Root Double Block and Bleed Valves

Features

- ⊙ Directly-mounted root valves available to the vessel or process pipe
- ⊙ Weld inlet connections in sizes from NPS 1/2 to NPS 2
- ⊙ 1/2 female NPT standard vent with plug
- ⊙ 1/2 female NPT standard outlet
- ⊙ Orifice (ball-and-needle-valve configuration): Ball 3/8 in. (9.5 mm), Needle 0.16 in. (4 mm);
Orifice (all-needle-valve configuration): 0.16 in. (4 mm) is standard, 0.25 in. (6.4 mm) and 0.38 in. (9.5 mm) are available upon request.

Primary: ball Secondary: ball Bleed: needle (configuration: BBN)

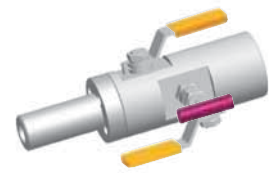
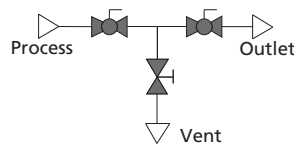
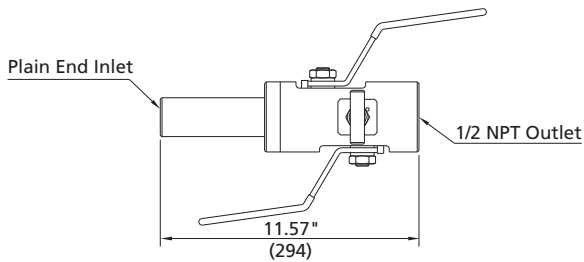

Primary: ball Secondary: ball Bleed: OS&Y (configuration: BBO)

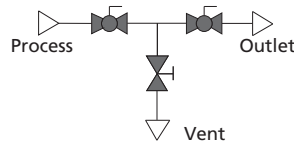
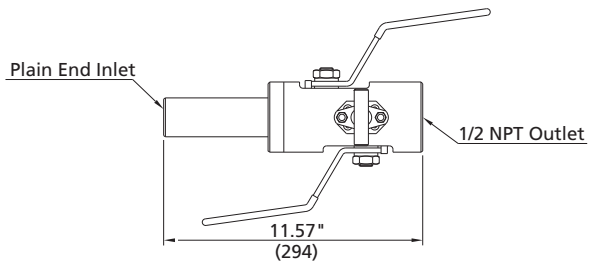

Primary: OS&Y Secondary: OS&Y Bleed: needle (configuration: OON)

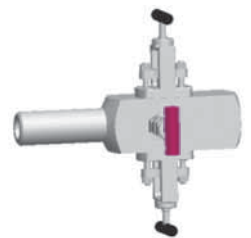
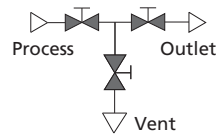
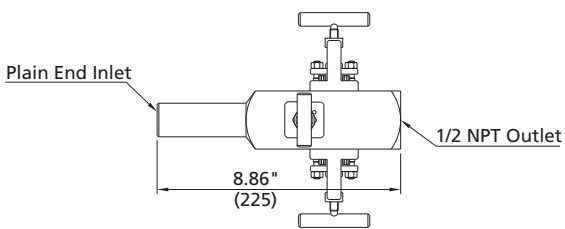

Primary: needle Secondary: needle Bleed: needle (configuration: NNN)

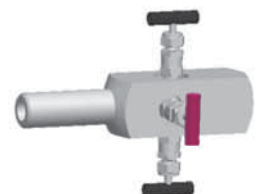
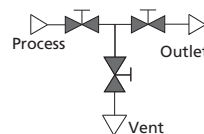
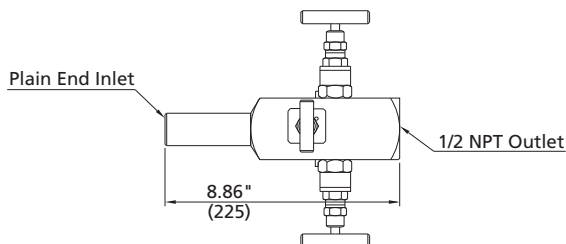

Dimensions are for reference only and are subject to change.

Monoflange Double Block & Bleed Valves

Features

- Piping and instrument valves in one body
- 1/4 female NPT standard vent with plug
- 1/2 female NPT standard outlet
- Orifice: 0.16 in. (4 mm) is standard, 0.25 in. (6.4 mm) and 0.38 in. (9.5 mm) are available for some flange sizes

Primary: OS&Y Secondary: needle Bleed: needle (configuration: ONN)

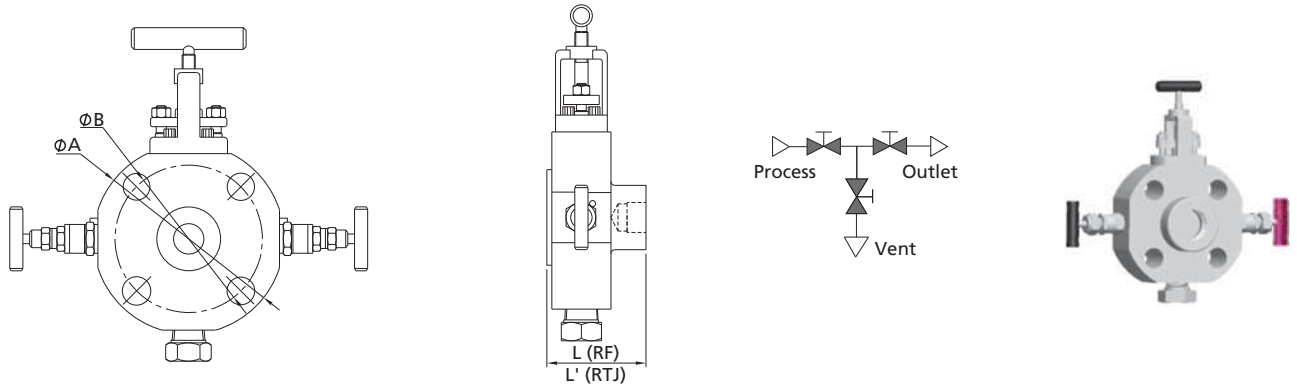

Primary: needle Secondary: needle Bleed: needle (configuration: NNN)

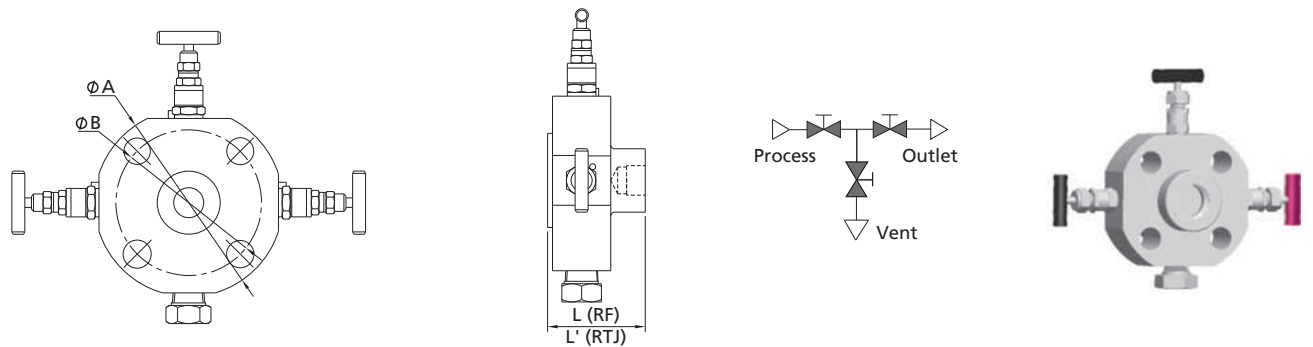

Primary: OS&Y Secondary: needle Bleed: needle (configuration: ONN, Block/Block/Bleed: X)

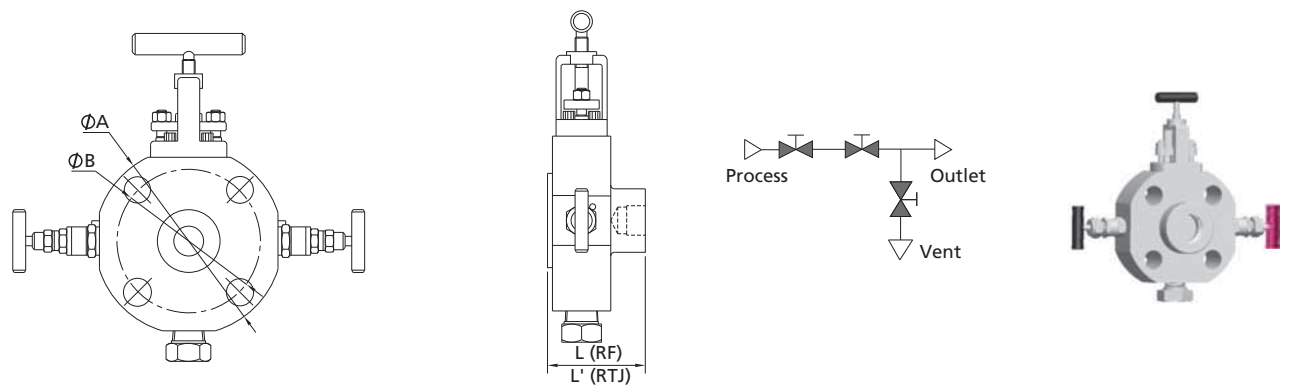

Manifolds

C-44 Block and Bleed Valves

Primary: needle Secondary: needle Bleed: needle (configuration: NNN, Block/Block/Bleed: X)

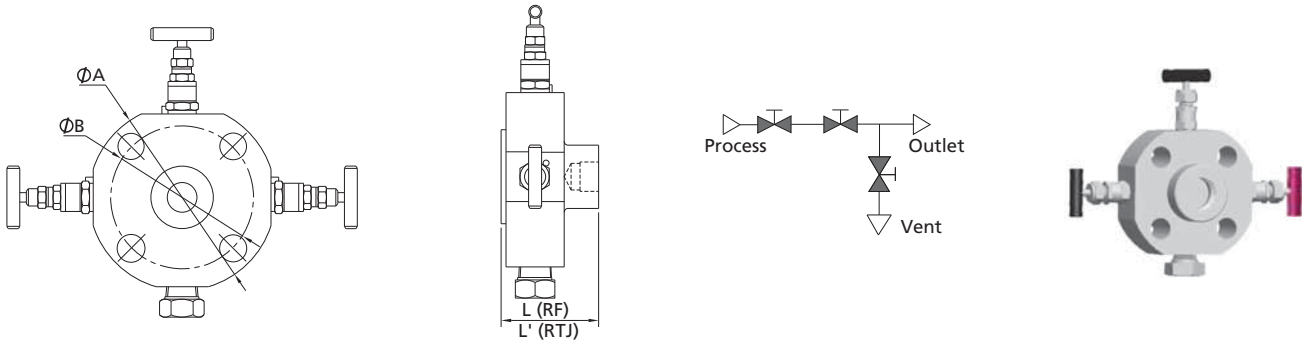

Flange Size	Bore Size in. (mm)	ASME Class	L in. (mm)	L' in. (mm)	ØA in. (mm)	ØB in. (mm)
NPS 1/2 (DN 15)	0.16 (4.0)	150	2.03 (51.6)	—	3.54 (90)	2.37 (60.3)
		300		2.03 (51.6)	3.74 (95)	2.63 (66.7)
		600			4.72 (120)	3.25 (82.6)
		900/1500			5.31 (135)	3.50 (88.9)
		2500			5.31 (135)	3.50 (88.9)
NPS 3/4 (DN 20)	0.16 (4.0)	150	2.03 (51.6)	—	3.94 (100)	2.75 (69.9)
		300		2.03 (51.6)	4.53 (115)	3.25 (82.6)
		600			5.12 (130)	3.50 (88.9)
		900/1500			5.12 (130)	3.50 (88.9)
		2500	2.11 (53.5)	2.11 (53.5)	5.51 (140)	3.75 (95.2)
NPS 1 (DN 25)	0.16 (4.0)	150	2.03 (51.6)	2.03 (51.6)	4.33 (110)	3.13 (79.4)
		300			4.92 (125)	3.50 (88.9)
		600			4.92 (125)	3.50 (88.9)
		900/1500	2.11 (53.5)	2.11 (53.5)	5.91 (150)	4.00 (101.6)
		2500	2.11 (53.5)	2.11 (53.5)	6.30 (160)	4.25 (108.0)
NPS 1 1/2 (DN 40)	0.16 (4.0)	150	2.03 (51.6)	2.03 (51.6)	4.92 (125)	3.87 (98.4)
		300	2.11 (53.5)	2.11 (53.5)	6.10 (155)	4.50 (114.3)
		600			7.09 (180)	4.87 (123.8)
		900/1500			2.19 (55.5)	2.19 (55.5)
		2500	2.67 (67.9)	2.67 (67.9)	8.07 (205)	5.75 (146)
NPS 2 (DN 50)	0.16 (4.0)	150	2.11 (53.5)	2.11 (53.5)	5.91 (150)	4.75 (120.7)
		300	2.19 (55.5)	2.19 (55.5)	6.50 (165)	5.00 (127.0)
		600			6.50 (165)	5.00 (127.0)
		900/1500			2.42 (61.5)	2.42 (61.5)
		2500	2.88 (73.4)	2.88 (73.4)	9.25 (235)	6.75 (171.4)

Dimensions are for reference only and are subject to change.

Injection Double Block & Bleed Valves

Function - injection

Injection of chemicals and other media into the process stream can be accomplished with this design. A check valve is installed to prevent process fluid from reaching the inlet injection position. There is a 0.125" (3 mm) hole in the injection nozzle orifice. The length of the injection nozzle orifice can be manufactured to meet customer requirements. The injection orifice can also be rotated. Injection valves can be provided in most of the styles and options offered for the DBB ranges.

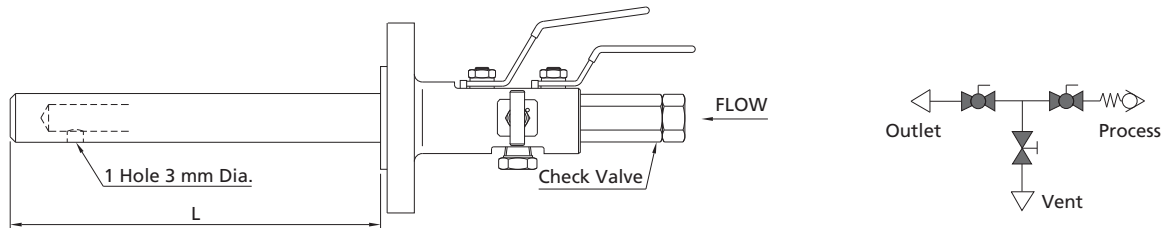

Injection Quill

The injection quill length (L) is manufactured to meet customer requirements. The injection nozzle is a 3 mm diameter hole (standard).

Integral Check Valve

This poppet type spring return valve has a FKM soft seal (standard).

Sampling Double Block & Bleed Valves

Function - sampling

This design is developed to remove a sample directly from process stream at full system pressure. The customized sampling probe extends from the pipe flange connection for correct sample removal. Sampling valves can be provided without a probe and valves can be provided in most of the styles and options offered for the DBB ranges.

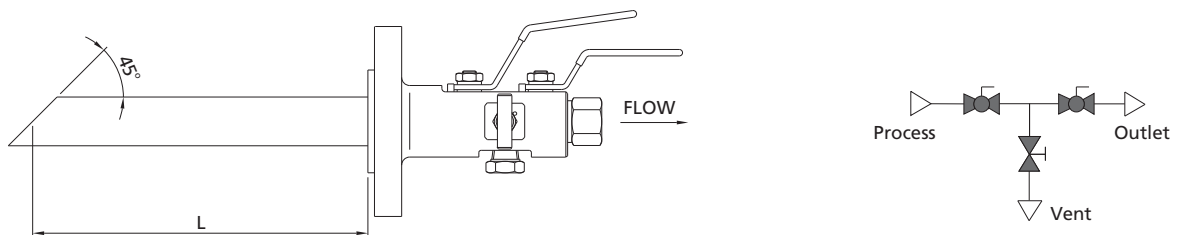

Sampling Probe

The sampling probe length (L) is manufactured to meet customer requirements.

Ordering Number Description

DBSS - 1BBO1 - FM16300 - FNS8 - 2V8 - HGSF2 - IE

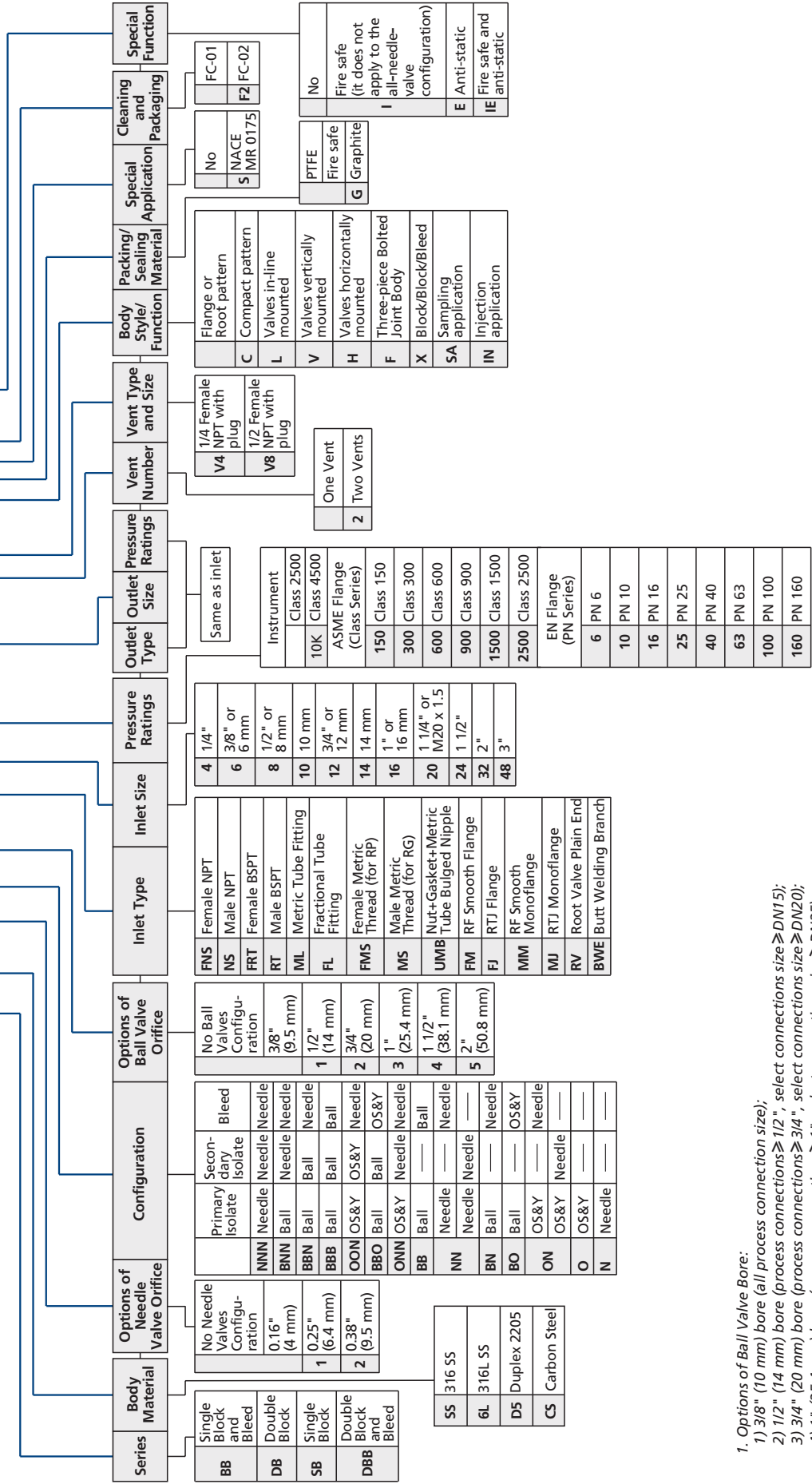

Series	Body Material	Options of Needle Valve Orifice	Configuration	Options of Ball Valve Orifice	Inlet Type	Inlet Size	Pressure Ratings	Outlet Size	Outlet Pressure Ratings	Vent Number	Vent Type and Size	Body Style/ Sealing Function	Packing/ Sealing Material	Special Application	Cleaning and Packaging	Special Function
BB	Single Block and Bleed	No Needle Valves Configuration (4 mm)	Primary Isolate Needle	Secondary Isolate Needle	FNS Female NPT	4	1/4"	Instrument	Class 2500	V4 Female plug	Flange or Root pattern	No	FC-01	No	Special Function	
																1
DB	Double Block	0.16" (4 mm)	BNN Needle	BBN Ball	NS Male NPT	6	3/8" or 6 mm	Class 4500	Class 4500	V8 Female plug	Compact pattern	NACE S	F2	FC-02	Special Function	
																1
SB	Single Block	0.25" (6.4 mm)	BBB Ball	BBB Ball	FRT Female BSPT	8	1/2" or 8 mm	ASME Flange (Class Series)	ASME Flange (Class Series)	One Vent	Valves in-line mounted	PTFE	Fire safe	E	Special Function	
																1
DBB	Double Block and Bleed	0.38" (9.5 mm)	OON OS&Y Needle	BBO Ball	ML Metric Tube Fitting	10	10 mm	150	Class 150	Two Vents	Valves vertically mounted	G	No	Special Function		
															1	10K
DBB	Double Block and Bleed	0.38" (9.5 mm)	OON OS&Y Needle	ONN OS&Y Needle	FL Fractional Tube Fitting	12	3/4" or 12 mm	300	Class 300	One Vent	Valves horizontally mounted	G	No	Special Function		
															1	10K
DBB	Double Block and Bleed	0.38" (9.5 mm)	OON OS&Y Needle	ONN OS&Y Needle	FMS Female Metric Thread (for RF)	14	14 mm	600	Class 600	Two Vents	Three-piece Bolted Joint Body	G	No	Special Function		
															1	10K
DBB	Double Block and Bleed	0.38" (9.5 mm)	OON OS&Y Needle	ONN OS&Y Needle	MS Male Metric Thread (for RG)	16	1" or 16 mm	900	Class 900	Two Vents	Valves vertically mounted	G	No	Special Function		
															1	10K
DBB	Double Block and Bleed	0.38" (9.5 mm)	OON OS&Y Needle	ONN OS&Y Needle	UMB Nut+Gasket+Metric Tube Bulged Nipple	20	1 1/4" or M20 x 1.5	1500	Class 1500	Two Vents	Valves horizontally mounted	G	No	Special Function		
															1	10K
DBB	Double Block and Bleed	0.38" (9.5 mm)	OON OS&Y Needle	ONN OS&Y Needle	FM RF Smooth Flange	24	1 1/2"	2500	Class 2500	Two Vents	Three-piece Bolted Joint Body	G	No	Special Function		
															1	10K
DBB	Double Block and Bleed	0.38" (9.5 mm)	OON OS&Y Needle	ONN OS&Y Needle	FJ RTJ Flange	32	2"	EN Flange (PN Series)	EN Flange (PN Series)	Two Vents	Valves horizontally mounted	G	No	Special Function		
															1	10K
DBB	Double Block and Bleed	0.38" (9.5 mm)	OON OS&Y Needle	ONN OS&Y Needle	MM RF Smooth Monoflange	48	3"	6	PN 6	Two Vents	Valves horizontally mounted	G	No	Special Function		
															1	10K
DBB	Double Block and Bleed	0.38" (9.5 mm)	OON OS&Y Needle	ONN OS&Y Needle	MJ RTJ Monoflange	10	PN 10	10	PN 10	Two Vents	Valves horizontally mounted	G	No	Special Function		
															1	10K
DBB	Double Block and Bleed	0.38" (9.5 mm)	OON OS&Y Needle	ONN OS&Y Needle	RV Root Valve Plain End	16	PN 16	16	PN 16	Two Vents	Valves horizontally mounted	G	No	Special Function		
															1	10K
DBB	Double Block and Bleed	0.38" (9.5 mm)	OON OS&Y Needle	ONN OS&Y Needle	BWE Butt Welding Branch	25	PN 25	25	PN 25	Two Vents	Valves horizontally mounted	G	No	Special Function		
															1	10K
DBB	Double Block and Bleed	0.38" (9.5 mm)	OON OS&Y Needle	ONN OS&Y Needle	MM RF Smooth Monoflange	40	PN 40	40	PN 40	Two Vents	Valves horizontally mounted	G	No	Special Function		
															1	10K
DBB	Double Block and Bleed	0.38" (9.5 mm)	OON OS&Y Needle	ONN OS&Y Needle	MU RTJ Monoflange	63	PN 63	63	PN 63	Two Vents	Valves horizontally mounted	G	No	Special Function		
															1	10K
DBB	Double Block and Bleed	0.38" (9.5 mm)	OON OS&Y Needle	ONN OS&Y Needle	RV Root Valve Plain End	100	PN 100	100	PN 100	Two Vents	Valves horizontally mounted	G	No	Special Function		
															1	10K
DBB	Double Block and Bleed	0.38" (9.5 mm)	OON OS&Y Needle	ONN OS&Y Needle	BWE Butt Welding Branch	160	PN 160	160	PN 160	Two Vents	Valves horizontally mounted	G	No	Special Function		
															1	10K

- Options of Ball Valve Bore:
 - 3/8" (10 mm) bore (all process connection size);
 - 1/2" (14 mm) bore (process connections ≥ 1/2", select connections size ≥ DN15);
 - 3/4" (20 mm) bore (process connections ≥ 3/4", select connections size ≥ DN20);
 - 1" (25.4 mm) bore (process connections ≥ 1", select connections size ≥ DN25);
 - 1-1/2" (38.1 mm) bore (process connections ≥ 1-1/2", select connections size ≥ DN40);
 - 2" (50.8 mm) bore (process connections ≥ 2", select connections size ≥ DN50).
- For more information about hazards and risks of oxygen-enriched system, please contact FITOK Group or our authorized distributors.
- Cleaning and Packaging:
 - FC-01: Standard cleaning and packaging for general industrial procedures.
 - FC-02: Special cleaning and packaging for wetted system components to ensure compliance with product cleanliness requirement as stated in ASTM G93 Level C.

NOTE: "Ordering Number Description" is a reference to understand the combination rules of FITOK product part number. Not all combinations are available.

FITOK Group

FITOK GmbH (Headquarter)

Sprendlinger Landstr. 115, 63069 Offenbach am Main, Germany
Tel.: +49 69 8900 4498 Fax: +49 69 8900 4495

FITOK, Inc.

13843 North Promenade Blvd., Suite 750, Stafford, Texas 77477, USA
Tel.: +1 281 888 0077 Fax: +1 281 582 4051

FITOK Incorporated

Block C, Zone E, Yingtai Industrial Park, Dalang Street,
Longhua District, Shenzhen, 518109, China
Tel.: +86 755 2803 2500 Fax: +86 755 2803 2619

FITOK Middle East Oil Equipment Trading LLC

208-209, Makateb Building, Airport Road, P.O.Box 185412, Deira, Dubai, UAE
Tel.: +971 4 2959 853 Fax: +971 4 2959 854

info@fitokgroup.com
www.fitokgroup.com

FK-IC-GV-13-EN-180716